

 **Drill
Doctor**[®]
The Drill Bit Sharpener



1. ALIGN BITS

2. SHARPEN BITS

3. SPLIT POINTS

JOURNEYMAN **400**
User's Guide
Guía del usuario
Mode d'emploi

Thank you...

for buying your Drill Doctor® 400. It will become a valuable tool because you will now have sharp drill bits before a project, during a project, and after a project.

I am very proud of the quality of our products and I am equally proud of the great people at Drill Doctor who design and produce them. If you have questions or need help with your Drill Doctor, please call **1-800-597-6170** and one of our customer representatives will be there to help. We support what we build!

Use this User's Guide to learn to operate your Drill Doctor. I also want to invite you to visit our website at **www.DrillDoctor.com**. There you will find:

- Demonstrations of all operations with the sights and sounds leading to successful drill bit sharpening
- Downloadable copies of the User's Guide
- Warranty registration
- Service and contact numbers

Again, thank you for buying a Drill Doctor. Now enjoy its convenience and quality.



Hank O'Dougherty, President, Drill Doctor®

Contents

English

Safety	2
Getting to Know Your Drill Doctor®	3
Identifying Basic Drill Bits	4
Anatomy of a Drill Bit	4
The Drill Doctor® Sharpening Process	5
Aligning the Drill Bit	5
Grit Tube Attachment	7
Sharpening the Drill Bit	8
Identifying Correctly Sharpened Drill Bits	9
Split Points	10
Creating or Replacing a Split Point	10
Identifying Correctly Split Bits	11
Sharpening Bits of Different Lengths and Diameters	12
Aligning and Sharpening Masonry Drill Bits	13
Questions and Answers	14
Drill Doctor® Maintenance	18
Accessories and User-Replaceable Parts	20
Warranty	21
Español	22
Français	45

Safety

- Carefully read this User's Guide before operating the Drill Doctor.
- When using electric tools, basic safety precautions should always be followed to prevent the risk of fire, electric shock and personal injury.
- Always disconnect the Drill Doctor when cleaning or inspecting. Make sure the switch is in the OFF position before plugging in the power cord.
- Do not use in wet or damp locations.
- Do not abuse the cord.
- Wear eye protection when using or cleaning the Drill Doctor.
- Never touch internal parts of the sharpener when it is turned on or plugged in. The rotating diamond wheel can cause injury.
- As with any power tool, the Drill Doctor should be kept out of the reach of children.

WARNING: Some dust created by power sanding, grinding, miscellaneous construction activities, as well as contents from the machine including the molding, wiring, grinding wheel, or any other parts may contain chemicals known to the State of California to cause cancer, birth defects or other reproductive harm and can be hazardous to your health.

Getting to Know Your Drill Doctor®

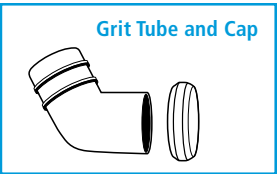
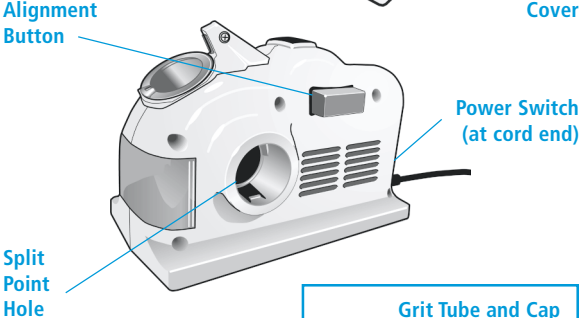
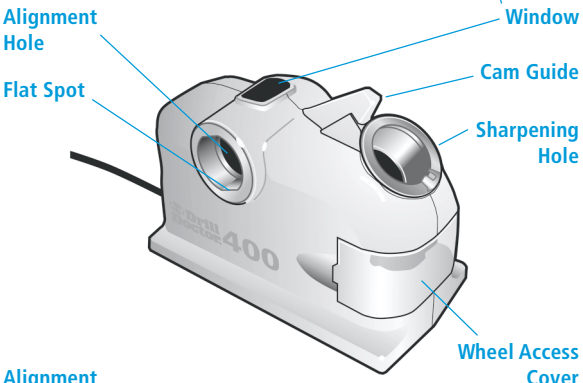
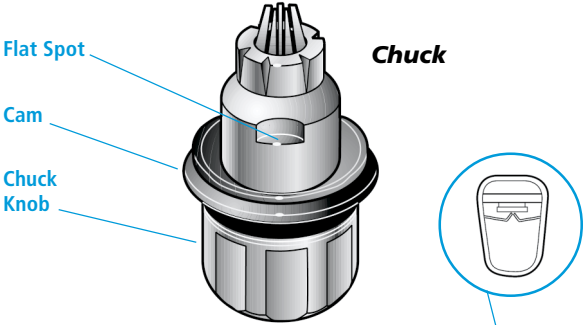

Identifying Basic Drill Bits

The Drill Doctor® is most efficient when used to sharpen a drill bit's original point angle. With its standard diamond grinding wheel it will sharpen high-speed steel, cobalt, TiN-coated, carbide and masonry drill bits.

It has been designed and engineered to sharpen three of the most common drill bit types:



Standard Point

This general purpose point is used for drilling softer materials like cold rolled steel, aluminum, and wood.



Split point bits are self-centering and are generally used for tempered steels, hard alloys or hard cast materials.



Masonry bits have a carbide insert at the point and are used for drilling materials like cement, brick, and ceramic.

Anatomy of a Drill Bit

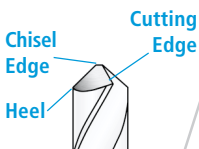

It is important to understand that each bit has a Chisel Edge, a Cutting Edge, and a Heel.

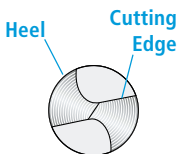

When viewing a well sharpened bit from the end, the entire surface from the Cutting Edge to the Heel will have a finely ground surface without ridges or indentations. And, the Heel will always be lower than the Cutting Edge.

The Drill Doctor® Sharpening Process

The sharpening process includes 3 easy procedures:

1. Align the bit in the Chuck.
2. Sharpen the bit.
3. Split the point (if you choose).

Be sure to complete all three of the procedures to sharpen and split a bit and always sharpen the bit prior to splitting it.

Aligning the Drill Bit

(See page 13 to align and sharpen a **Masonry drill bit**.)

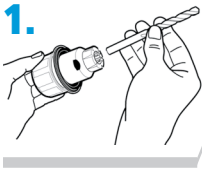

Turn the Chuck Knob to the left to open the Chuck and Insert your drill bit into the Chuck (about halfway in is fine for now).

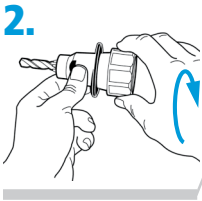

Turn the Chuck Knob to the right to tighten.

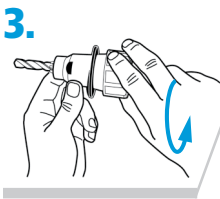

Turn the Chuck Knob to the left just until the bit will slide and rotate in the Chuck.

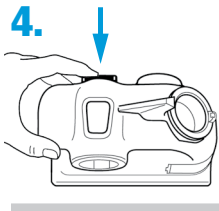

With one hand, press in **and hold** the Alignment Button on the Drill Doctor (**do not release until Step 7**).

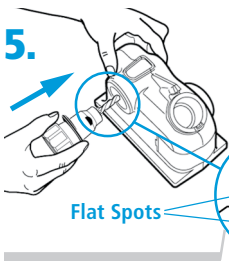

With your free hand, insert the Chuck into the Alignment Hole—make sure the flat spots on the Chuck match the flat spots in the hole.

At this point, the Chuck should be inserted into the Alignment Hole with the flat spots hidden, and the Chuck should be locked in the hole.

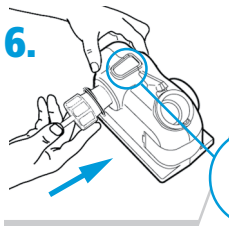

With the Alignment Button held in, push the drill bit forward until it is against the Drill Stop.

Look at the drill bit through the Window over the Alignment Hole—it should be against the Drill Stop.

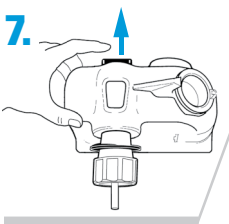

Release the Alignment Button.

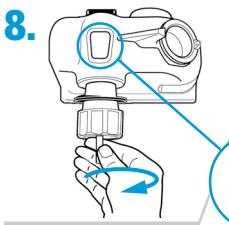

While looking in the Window, turn the drill bit **to the right** until you feel the Bit Clamps grip the bit at its **narrowest point** (the bit is now difficult to turn either way).



Turn the Chuck Knob to the right until it is tight but make sure that the bit did not turn or the Chuck did not back out of the Hole.

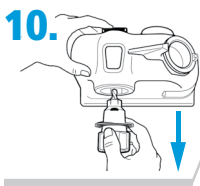

10. Press the Alignment Button in and remove the Chuck from the Alignment Hole. Tighten the Chuck Knob firmly.

You are now ready to sharpen the drill bit.

Grit Tube Attachment

The grit tube attachment is not critical for the function of the Drill Doctor; however using it offers the following benefits:

- Extends the life of your Drill Doctor by removing the grit created when sharpening your drill bits.
- Keeps your Drill Doctor in better operating condition with less maintenance
- Keeps your work area safe and clean
- Easily attaches to a vacuum to clean your Drill Doctor

Using the Grit Tube Attachment

11. Insert the ribbed end of the grit tube into the split-point hole. (The second rib will be flush with the split-point hole).

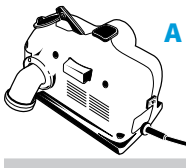

For Use with Grit Tube Only

- Adjust position of the grit tube as shown in Illustration A.
- Place the cap on the open end of the grit tube.
- Sharpen as usual.
- After sharpening, remove cap to dispose of grit.

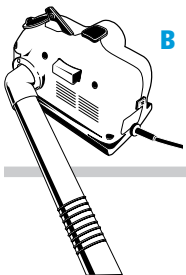

For Use with Shop Vac

- Adjust position of the grit tube as shown in Illustration B.
- Place the 1 1/4" vacuum hose attachment on the open end of the grit tube.
- Turn on your vacuum before sharpening. Sharpen as usual.
- Grit will be suctioned into shop vac. Dispose of debris as usual.

Sharpening the Drill Bit

12.



Insert the Chuck into the Sharpening Hole.

It will be easier to sharpen the bit if you stand up.

13.

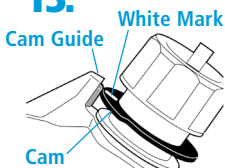

Align one of the white marks on the Cam with the Cam Guide, and **push the Power Switch to the ON (I) position.**

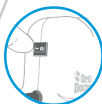

Before sharpening you should know:

- Keep the Cam in contact with the Cam Guide as you sharpen—push the Chuck straight into the hole.
- Only **light pressure** is required—let the diamond wheel do its work.
- Turn the Chuck an **even number** of half-turns:
 - 3/32 inch bits—use **2 to 4** half-turns,
 - 1/8 inch bits—use **4 to 6** half-turns,
 - 3/8 inch bits—use **6 or more** half-turns.
- You will hear a grinding noise as you complete each half-turn and each side of the bit face is ground. (**zzzzzzzzzz**)
- The Chuck will rock as you turn it and the Cam rides on the Guide.

14.

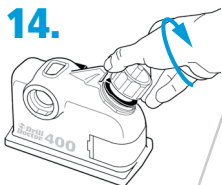

Turn the Chuck in complete half-turns **to the right** so the white marks on the Chuck move to the Cam Guide one after the other. It is important that your half-turns be continuous—do not stop or hesitate in the middle.

Identifying Correctly-Sharpened Drill Bits (And What to Do With Those That Aren't!)

Correctly Sharpened

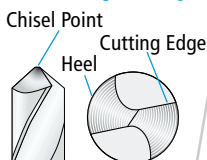

The entire surface from the Cutting Edge to the Heel will have a finely ground surface without ridges or indentations. And, the Heel will always be lower than the Cutting Edge.

Misaligned

The Chisel Edge is ground flat.

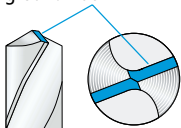

Cause

Bit Clamps did not grip drill bit at narrowest point in the aligning process (Page 6).

Solution

Realign the bit by carefully following steps 1 through 10 on Pages 4 to 7.

Heel Same Height or Higher Than the Cutting Edge

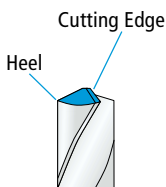

Cause

Sharpening Hole not functioning properly.

Solution

The Sharpening Hole is where you rotate the Chuck when sharpening. Locate the bump on the bottom of the Hole and press down on it. If the tube does not spring back, please call our Technical Support group at 1-800-597-6170 or 541-552-1301 for assistance.

Cause

Dirty Chuck.

Solution

Insert a drill bit into the Chuck, tighten it, then press the bit against a hard surface. Does the bit slide in the Chuck? If so, clean the Chuck as described on Page 18.

Split Points

Split point drill bits prevent walk-around on the material before they begin to cut.

This feature is described as self centering. The need to center punch is effectively eliminated. A standard drill bit chisel point has to wear an area in the middle of the hole to be drilled before the cutting edges will remove material. Due to its additional cutting lips along the chisel edge, a split point will begin cutting immediately. Up to 70% less thrust (when compared to a non-split or conventional point) is required to drill a hole with a split point.

Creating or Replacing a Split Point

Always align and sharpen a bit before splitting it. With the Splitting Hole facing you, notice that the Splitting Hole has flat spots like the Alignment Hole and a white mark on the case next to the Hole. When inserting the Chuck into the Hole, align the white mark on the Chuck with the white mark on the case. As you push the Chuck slowly into the Hole, the flat spots on the Chuck and in the Hole should match. The Chuck will be tight in the Hole.

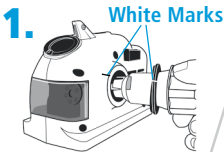

With the machine turned on, match the white line on the Chuck with the white line next to the Splitting Hole.

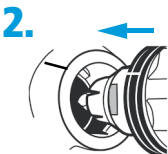

Insert the Chuck into the Splitting Hole **so the flat spots match (white line to white line) and push slowly and firmly** until the Chuck stops (you will hear a grinding sound). Push **hard** until the Chuck stops.

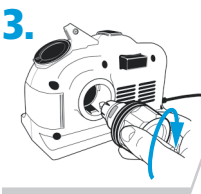

Pull the Chuck out slightly until the flat spots release, and turn it a half-turn either way. With the white lines and flat spots aligned, push it in **firmly and slowly** until it stops. The second side of the bit is now split.

4.

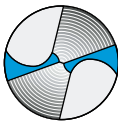

Check the tip of the bit carefully to determine that both sides of the bit are split equally. Compare it to this illustration. If it does not match, study the information below.

Identifying Correctly Split Drill Bits (And What to Do With Those That Aren't!)

Correctly Split

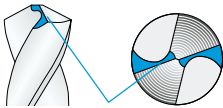

Split line

Split lines are nearly straight across.

Undersplit

Split lines do not meet in the center but Chisel Edge remains.

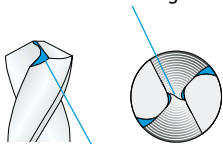

Not enough material has been removed from the heel of the drill bit.

Solution

More grinding is needed for larger drill bits. If one side of the bit is undersplit, insert the Chuck into the Splitting Hole again and split both sides. Push the Chuck into the Hole until it stops. Repeat until the split sides are equal and look like the correctly split bit shown above.

Oversplit

Too much material removed.

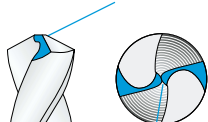

Split lines are joined in the center and Chisel Edge has been removed.

Solution

After splitting, do not remove the bit from the Chuck. Reinsert the chucked bit into the **Sharpening Hole** and remove enough of the tip until the split tip looks like the correctly split bit above.

Sharpening Bits of Different Lengths and Diameters

Drill Bits Of Different Sizes

Too many rotations of a small diameter bit may result in incorrect sharpening and too few on a large bit may not sharpen enough.

3/32 inch bits—use **2 to 4 half-turns**,

1/8 inch bits—use **4 to 6 half-turns**,

3/8 inch bits—use **6 or more half-turns**.

Large Drill Bits

Large drill bits (3/8" to 1/2") will require increased pressure and more half-turns (20 or more) of the Chuck. A well sharpened bit will have a smooth surface from cutting edge to heel. It may take two or three complete sharpenings (repeat all steps) to resharpen a very dull or chipped large drill bit.

Short Drill Bits

Often bits smaller than 1/8" in diameter are so short they will not stick out of the back of the Chuck. After inserting a small bit into the Chuck and while holding the Alignment Button in, insert the Chuck into the Alignment Hole. Then, insert a finger into the back of the Chuck Knob and push the bit forward against the Drill Stop. Look through the Window and make sure the Bit Clamps grasp the bit at the narrowest point when you release the Alignment Button.

Correct

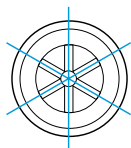

Incorrect

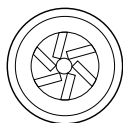

Tighten the Chuck Knob, but **before sharpening small bits, look through the back of the Chuck** to be sure all Chuck Jaws are straight against the drill bit. If the Jaws appear to be out of line, move the Chuck Knob slightly to the left just until the Jaws straighten—**do not loosen the Chuck Knob** or the bit will loosen and the alignment will be lost. Now, sharpen the bit in the usual manner.

Aligning and Sharpening Masonry Drill Bits

1.



Insert your masonry bit in the Chuck in the same manner as other bits (See page 5).

2.

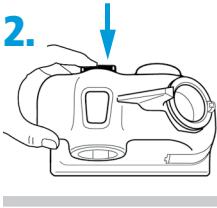

Push the Alignment Button back to the housing and **hold it in through Step 4**. Insert the chucked drill bit to the stop. **Bit Clamps are not used when aligning masonry bits.**

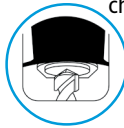

3.

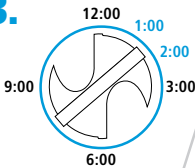

While looking through the window, start with the carbide tip of the bit straight up and down, and then turn it 1/8 turn to the right (the carbide tip should point to between the 1:00 and 2:00 o'clock position when looking at a clock face).

4.

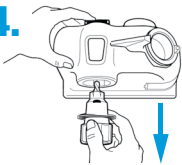

Tighten the Chuck Knob and remove the chuck from the Alignment Hole. Release the Alignment Button and tighten the Chuck.

5.

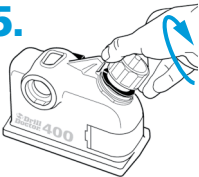

Now, sharpen the bit in the Sharpening Hole. Always use an even number of half-turns when sharpening. Start with four half-turns and then add as many half-turns as needed.

Note: The Drill Doctor will place a curved grind on the carbide insert, altering the appearance of the factory point.

Questions and Answers

1. Question:

When I aligned the drill bit and sharpened it, why was no material removed?

Answer:

This happens when the bit is not protruding out of the Chuck far enough. You may have allowed the Alignment Button to knock the drill back into the Chuck when aligning the bit. Carefully realign the bit in the Alignment Hole again. Make sure the drill is pushed all the way against the Drill Stop before you release the Alignment Button.

2. Question:

I sharpened the bit. Why will it not cut?

Answer:

This happens when the heel on the bit is higher than the cutting edge (negative relief). Realign the drill and resharpen in the Sharpening Hole.

Maintain consistent inward light pressure during the half-turns of the Chuck.

You may have a specialty drill bit. Slow and Fast Spiral, Helix, Turbo Flutes, and Raised Margin drill bits are considered specialty bits. To sharpen them, align them in the Chuck as you do standard bits. Check the position of the two Flats on the Chuck and draw an imaginary line from the middle of the flat up through the drill bit ($3/32$ " to $1/2$ ").

When aligning, start with the Bit Clamps on the narrow part of the bit, then turn the bit clockwise to approximately the 1:00 o'clock position. Hold the bit so it will not move and tighten the Chuck. You may have to move the drill bit clockwise in the Chuck more than once until it sharpens correctly.

If the chisel edge moves too far to the right, realign the bit and adjust again.

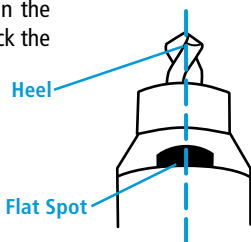

3. Question:

Why is the drill point off center?

Answer:

If the tip of the drill bit appears to be sharpened off center, check the following items:

- You may not have done an even number of half-turns when you sharpened and one face of the bit was ground more than the other. Always use an even number of half-turns when you sharpen.
- Make sure that there are no particles between the chuck jaws and the drill bit which could hold it off center.
- Make sure the bit is not loose in the Chuck.
- During the sharpening process be sure to keep the same pressure on each half-turn.

4. Question:

What can I do about flat spots on the bit point between the cutting edge and the heel?

Answer:

The flat spots on a sharpened bit are the result of an incomplete or paused half-turn of the Chuck in the Sharpening Hole. To correct, apply **light**, not firm inward pressure and rotate the Chuck smoothly while sharpening. Be sure to complete the half-turns.

5. Question:

Why is the chisel edge on my drill bit flat?

Answer:

During the alignment process the Bit Clamps were gripping the high points of the drill bit. Realign the drill bit making sure that the Bit Clamps are located in the narrowest section of the bit.

6. Question:

Why are my small drill bits grinding off-center?

Answer:

After aligning the small bit, look into the back of the chuck and determine if the jaws are straight against the bit. If the jaws appear to be out of line, move the Chuck Knob slightly to the left just until the Jaws straighten. Do not loosen the Chuck Knob or the bit will loosen and the alignment will be lost. If that happens, you will need to align the bit again.

7. Question:

Why was my drill bit sharpened improperly?

Answer:

The most common cause of improper sharpening is improper drill bit alignment.

Key causes are:

1. Drill point not pushed all the way to the Drill Stop.
2. Chuck not pushed all the way into the Alignment Hole.
3. Drill not aligned in the Bit Clamps correctly.

In order to correct these problems be sure the Chuck is all the way in the Alignment Hole with the flats entirely hidden. The drill point must be **against** the Drill Stop and the Bit Clamps must be at the narrowest part of the drill bit.

8. Question:

Why is my split point uneven?

Answer:

Page 11 shows a drill point that is undersplit and a drill point that is correctly split. To correct an uneven point split, insert the Chuck into the Splitting Hole and split both sides again. Push the Chuck into the Hole until it stops. Repeat until the split sides are equal and look like the correctly split bit shown above.

9. Question:

Why does the drill bit back up into the Chuck during the sharpening procedure?

Answer:

Make sure the bit is tight in the Chuck before sharpening. Your Chuck may be dirty. Follow the steps for cleaning the Chuck on page 18.

10. Question:

When splitting, why don't I hear a grinding sound?

Answer:

The Chuck is not seated properly in the flat spots of the Splitting Hole.

When inserting the Chuck into the Splitting Hole (with the Splitting Hole facing you), align the flat spots and move the Chuck either way until the flat spots mesh. Firmly and slowly push the Chuck into the hole until the grinding sound stops.

11. Question:

Can I change a 135-degree drill bit into a 118-degree drill bit?

Answer:

You can change the degree angle of any drill bit from 135 degrees to 118 degrees.

The alignment and sharpening procedure will need to be performed three or more times to remove the old angle and produce the new angle desired.

Drill Doctor® Maintenance

After sharpening 20 to 25 drill bits, the drill bit grinding dust will accumulate in the grinding compartment. Grinding particles will promote wear in the Alignment, Sharpening, and Splitting Holes and Chucks, so cleaning on a consistent basis can add life to your machine. **Before any maintenance or cleaning is performed, be sure to unplug your Drill Doctor.®**

Removing the Wheel Cover

Unplug the Drill Doctor.® Using the narrow end of the wrench provided (or a flat head screwdriver), insert it into the slot of the clear Wheel Cover on the front of the machine and use a twisting motion to pry the cover off.

Cleaning Your Drill Doctor®

Unplug the Drill Doctor.® Shake accumulated drill bit grinding dust from behind the Wheel Cover into a disposable container. Remove dust particles around the wheel with a small dry brush. Dispose of the container and drill bit dust in a safe and environmentally approved manner. With a dry cloth wipe the inside and outside of the three Holes to remove any grinding dust that may have accumulated. A standard 1" vacuum hose works equally well.

Cleaning the Chuck

With compressed air, blow out the Chuck from the Knob end. After 20 to 25 sharpenings, you may need to disassemble the Chuck for cleaning:

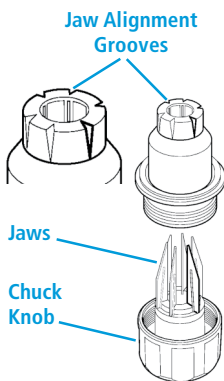

- **Keep the Chuck upright** (vertical) and remove the Chuck Knob.
- Do not remove the springs or Jaws.
- Use a small brush or rag to remove all grinding particles.
- Reassemble with all of the Jaws in their respective grooves. If some Jaws do not slip into their grooves on the inside of the Chuck, reach through the hole in the bottom of the Chuck Knob (or use a paper clip or small bit) and align them.

Determining If a Change of the Diamond Sharpening Wheel Is Required

Reverse the grinding wheel before you replace it. The grinding wheel supplied with the Drill Doctor® is designed to give you long and trouble free service, with an average of more than 200 sharpenings.

The diamond wheel may need to be changed if:

1. Sharpened drill bits burn or turn blue no matter how fast or slow you rotate the chuck.
2. When touching the sharpening wheel (with the machine disconnected), the lower portion feels too smooth (nonabrasive).
3. When sharpening the drill bit, it takes too many half-rotations to sharpen.

If you sharpen only 3/32" to 1/2" bits, you can double the life of the diamond wheel by reversing it. Bits larger than 1/2" use the entire diamond wheel surface so reversing will not be an advantage. Contact the store or dealer where you purchased the Drill Doctor® to purchase a standard or coarse replacement sharpening wheel.

Reversing or Replacing Your Diamond Sharpening Wheel

1. Unplug your Drill Doctor®, make sure machine is cool, then remove wheel cover.

2.

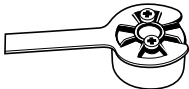

Use wrench supplied with your Drill Doctor® to lock sharpening wheel in place.

3.

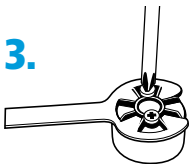

With Phillips-head screwdriver, remove the two screws and wheel retainer.

4.

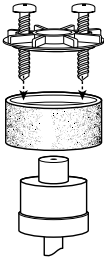

Remove worn wheel by twisting slightly and lifting wheel off shaft. Install new wheel and reinstall wheel retainer and screws. Don't over-tighten mounting screws. Remove the wrench and replace the wheel access cover before turning on the machine.

User Replaceable Parts

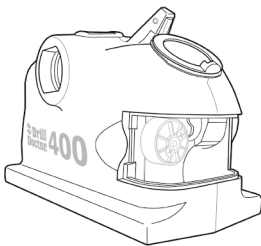

180 grit Standard Diamond Sharpening Wheel
(Part # SA01326GA)

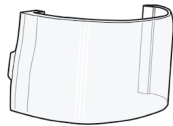

Hub Wrench
(Part # PP01336SF)



3/32" to 1/2" Chuck
(Part # SA01504PA)

Wheel Access Cover
(Part # PP40150PF)

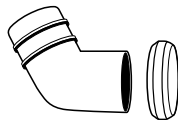

Grit Tube and Cap
(Part # DA40120PF)

Accessories

- 1/2"-3/4" Chuck
(Part # DA40170PF)
- 100 Grit Coarse Diamond Sharpening Wheel
(Part # SA01328GA)
- Carrying Case
(Part # PP40400PF)

The use of any accessory other than one recommended in this user's manual may present a risk of personal injury.

Drill Doctor® Warranty

Your Drill Doctor is warranted to be free of defects due to workmanship or design for 1 year from the purchase date. If your Drill Doctor fails to operate, or if any operating problem occurs, contact Drill Doctor Technical Service toll free at:

1-800-597-6170
(U.S. and Canada only)

Do not return this product to the store where you purchased it. Do not attempt any service or repairs other than those suggested by a Drill Doctor Technical Service Representative (TSR). During the period of warranty, Drill Doctor will, at our discretion, repair or replace this product free of charge and refund postage or shipping charges providing that the following conditions are met:

1. A copy of the proof of purchase is provided.
2. The product has been operated for the purpose intended as described in the operating instructions and has not been abused or mishandled in any way.
3. The product has not been dismantled and no service or repairs have been tempted other than those suggested by a by a Drill Doctor TSR.
4. The Return Goods Authorization number (RGA #) (assigned by the Drill Doctor TSR) is written on the shipping label. Please make certain to package items in such a way as to eliminate further damage during shipping. Ship via a traceable carrier and properly insure the package.

No CODs are accepted. Unapproved shipping charges are non-refundable.

Complete and mail back the Warranty Registration & Customer Survey, or register online at:

www.DrillDoctor.com

Please Fill in the Following for Your Records.

Drill Doctor® Model #: _____

Date of Purchase _____ / _____ / _____

Purchased from _____



Phone: 1-888-MYDRILL (693-7455)

Professional Tool Manufacturing, LLC

P.O. Box 730

210 E. Hersey St.

Ashland, OR 97520 USA

Fax: 541-552-1377

Email: tech@DrillDoctor.com

Web: www.DrillDoctor.com



Phone: 1-888-MYDRILL (693-7455)

Professional Tool Manufacturing, LLC

P.O. Box 730

210 E. Hersey St.

Ashland, OR 97520 USA

Fax: 541-552-1377

Email: tech@DrillDoctor.com

Web: www.DrillDoctor.com

**Drill Doctor[®] is a registered trademark of
Professional Tool Manufacturing, LLC.**